

LS2-F53A

パーツブック
PARTS BOOK

一本針本縫総合送り水平釜ミシン<返し縫い付>

SINGLE NEEDLE UNISON FEED LOCK STITCHER WITH HORIZONTAL
ROTARY HOOK AND REVERSE STITCHING

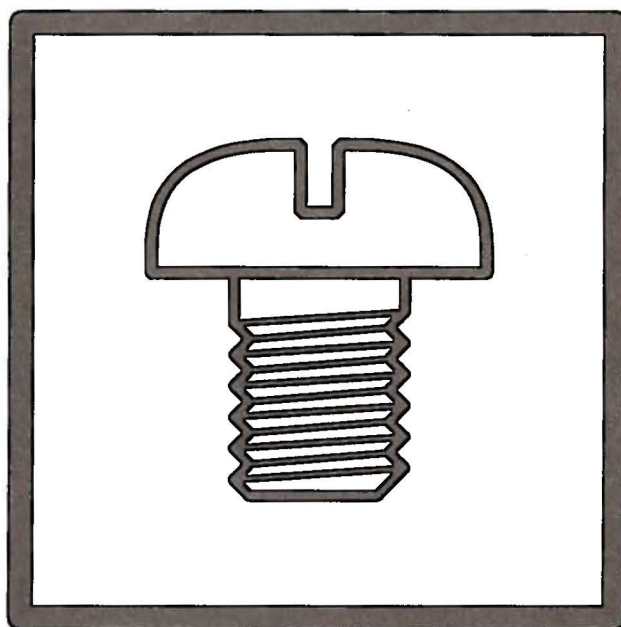

brother®

From the library of: Superior Sewing Machine & Supply LLC

1. 糸調子・針板關係 / Thread tension, Needle plate

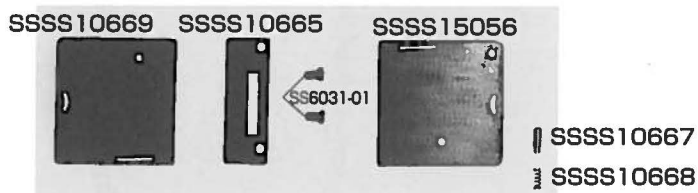
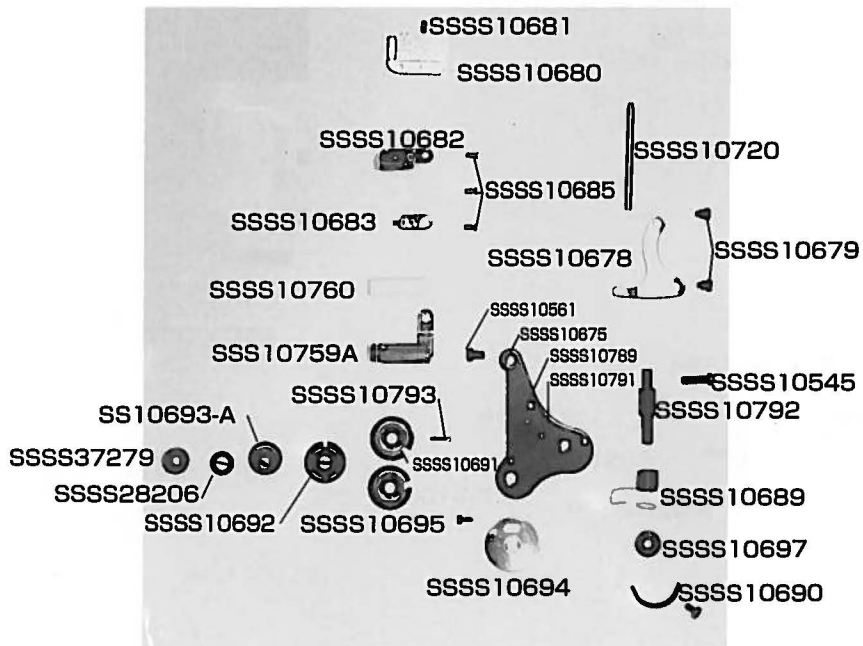
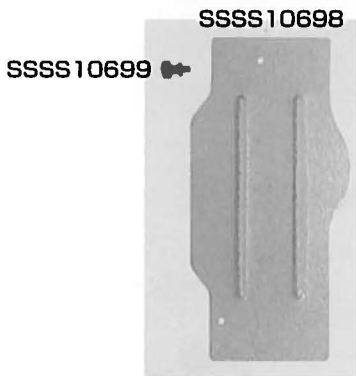

2. 上軸・天秤関係 / Upper shaft, Thread take-up

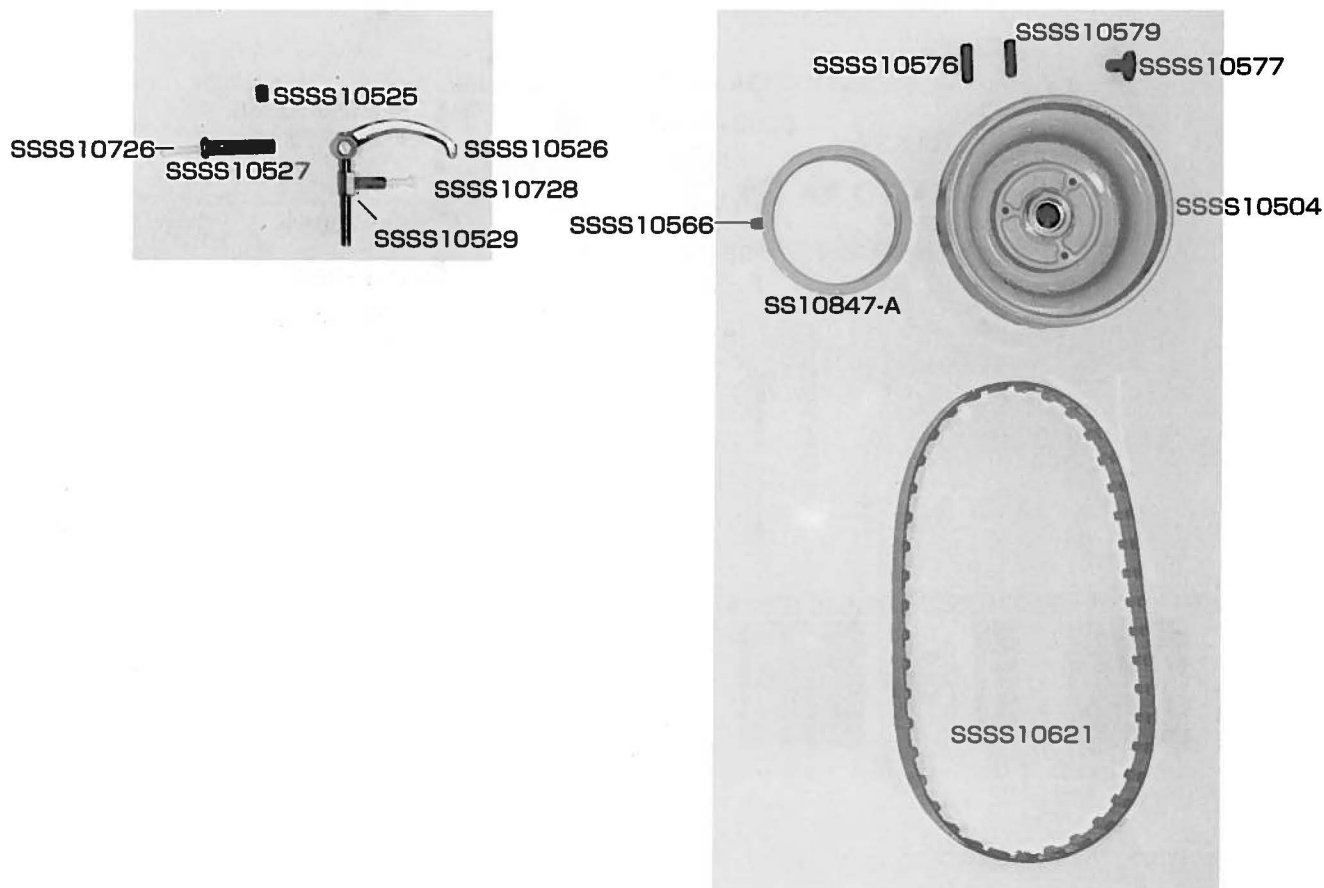
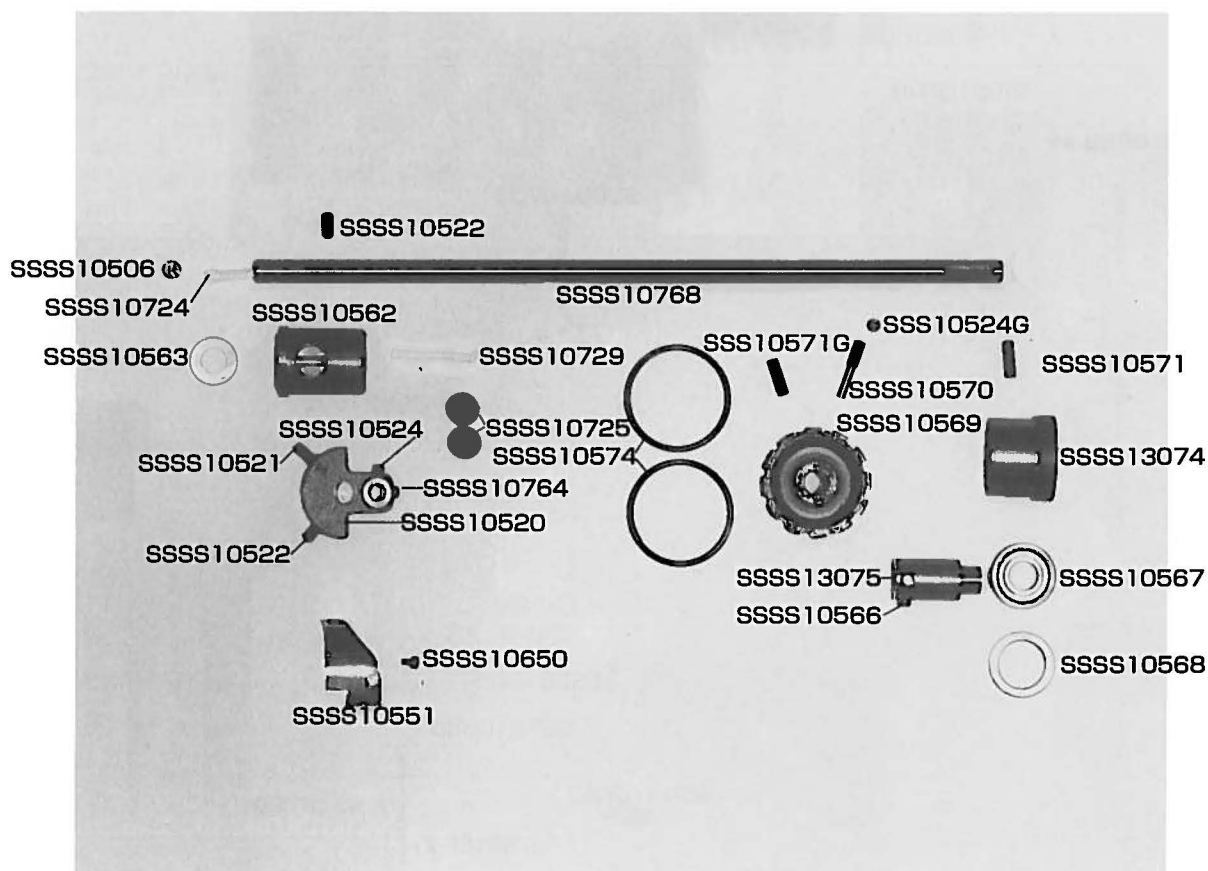

3. 針棒・上送り関係 / Needle bar, Upper feed Mechanism

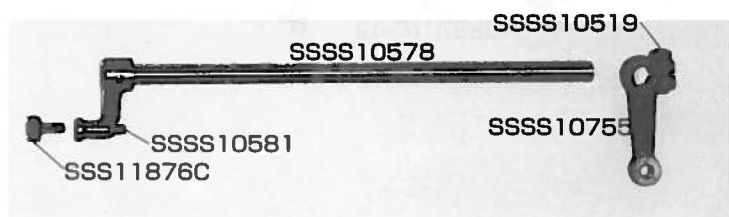
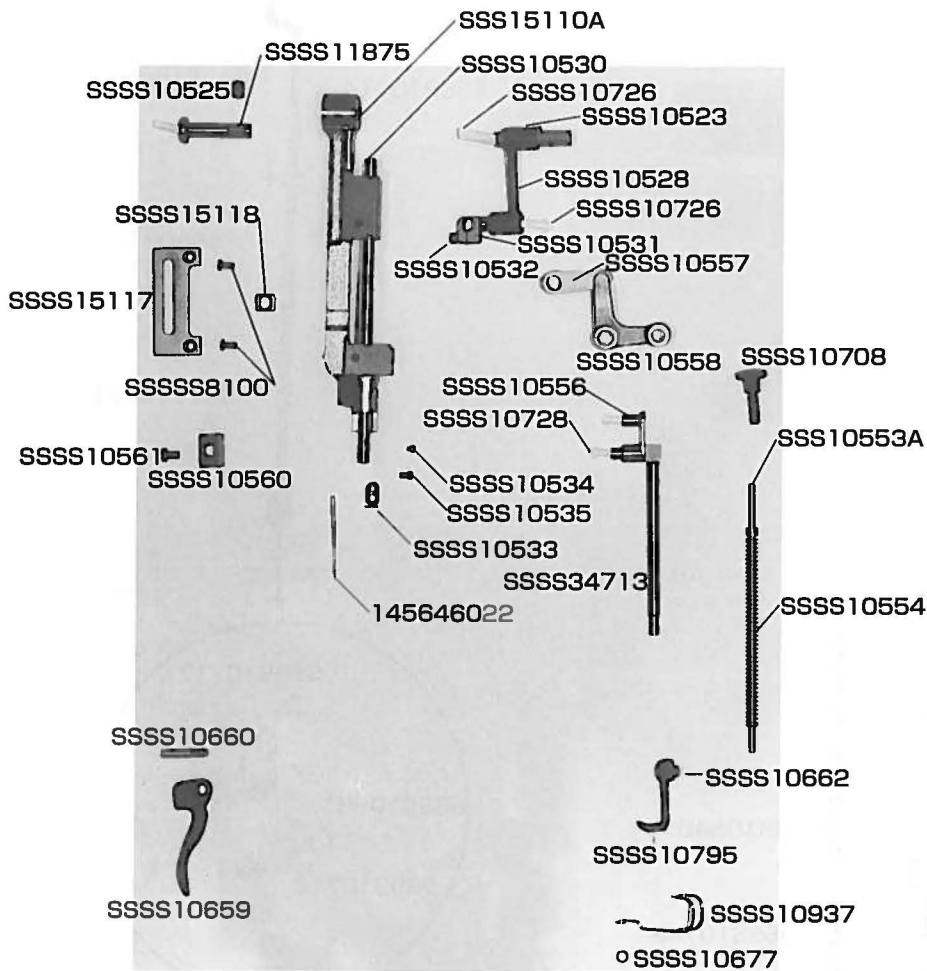
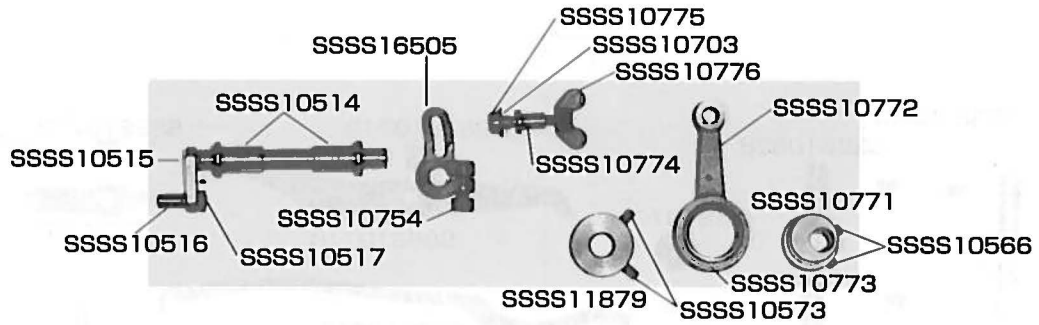

4. 押え関係 / Presser foot Mechanism

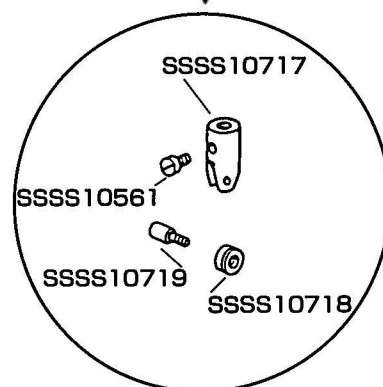
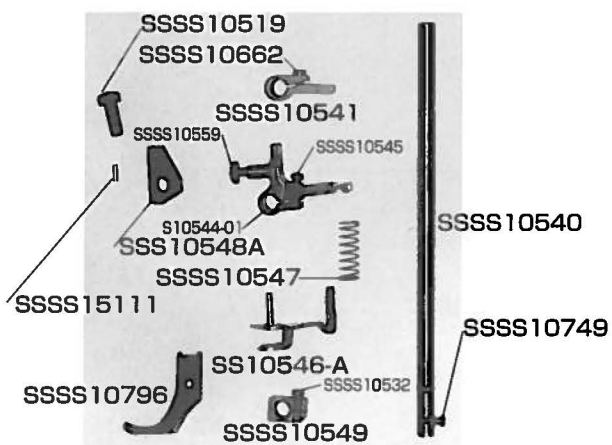
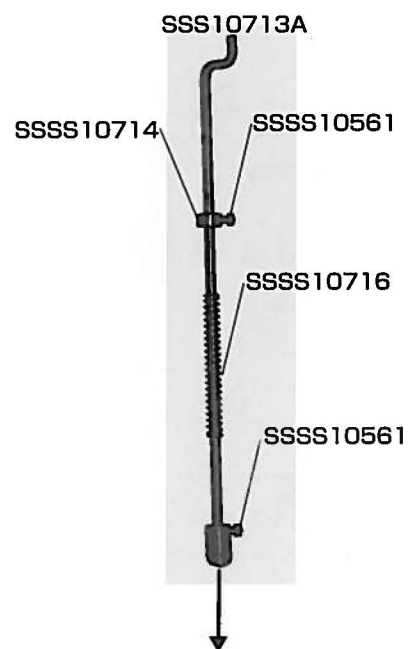
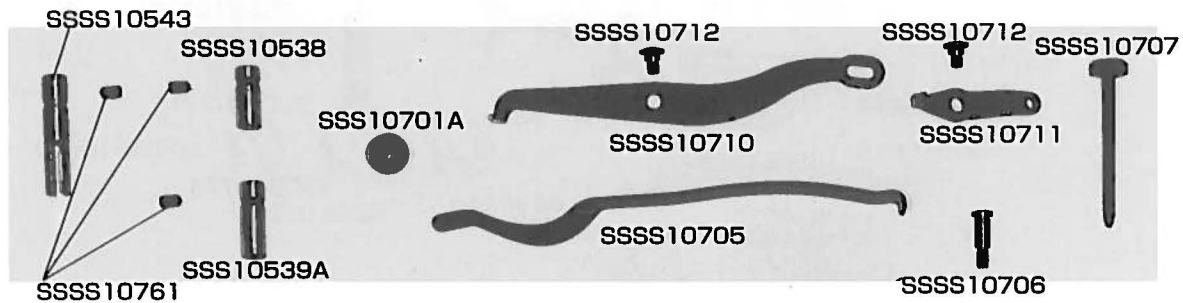

5. 下送り関係 / Lower feed Mechanism

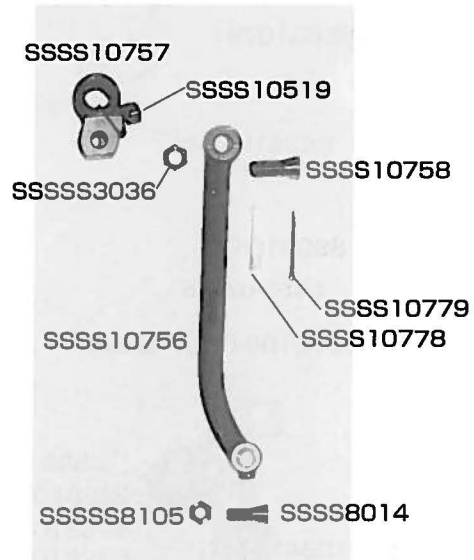
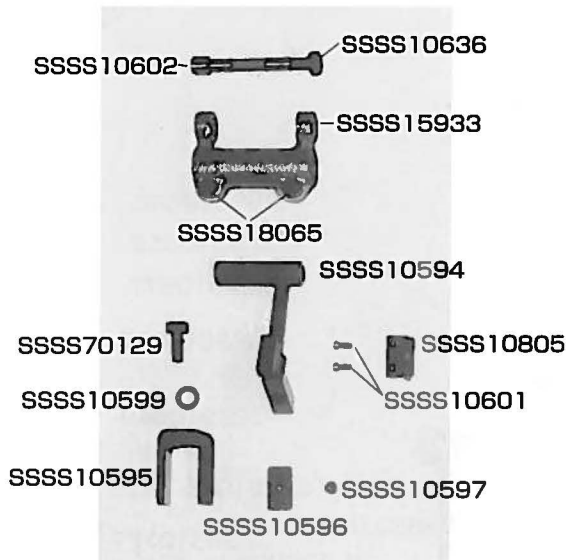
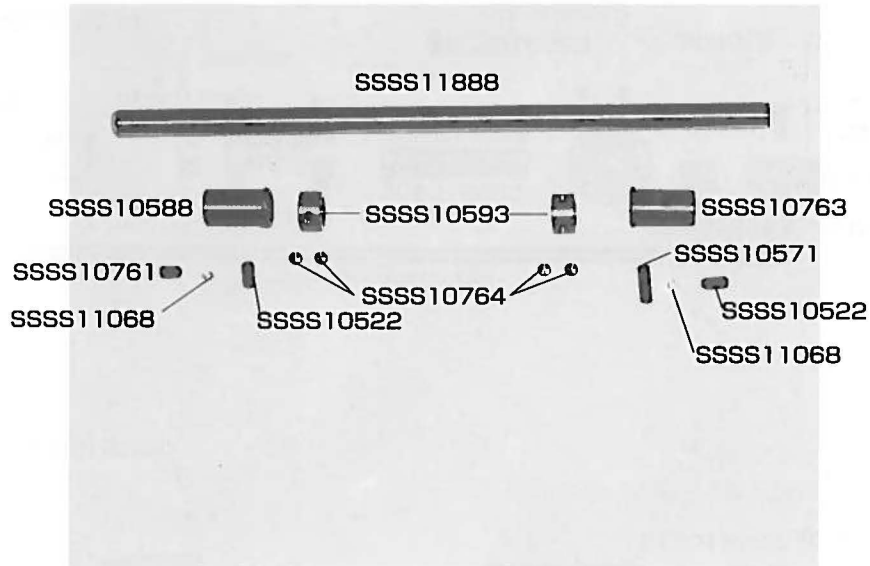

6. 下軸関係 / power shaft Mechanism

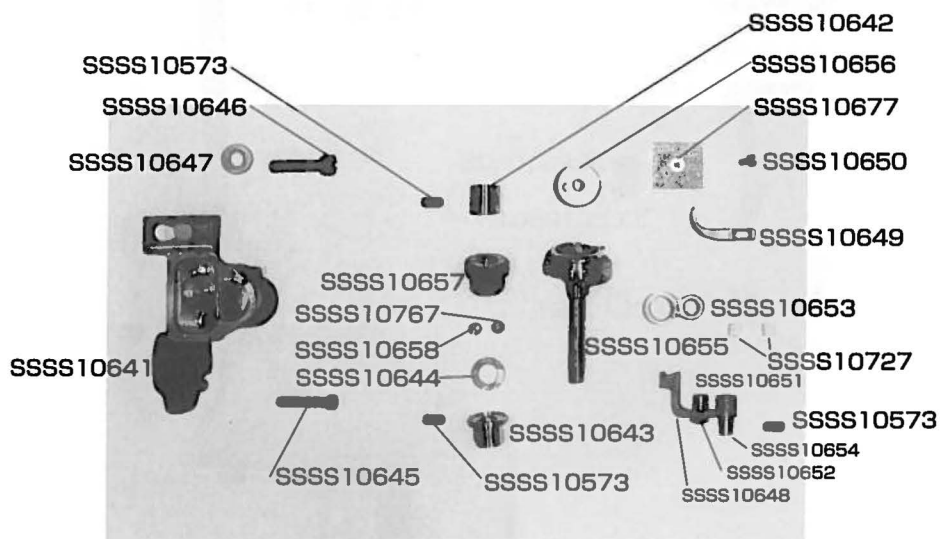
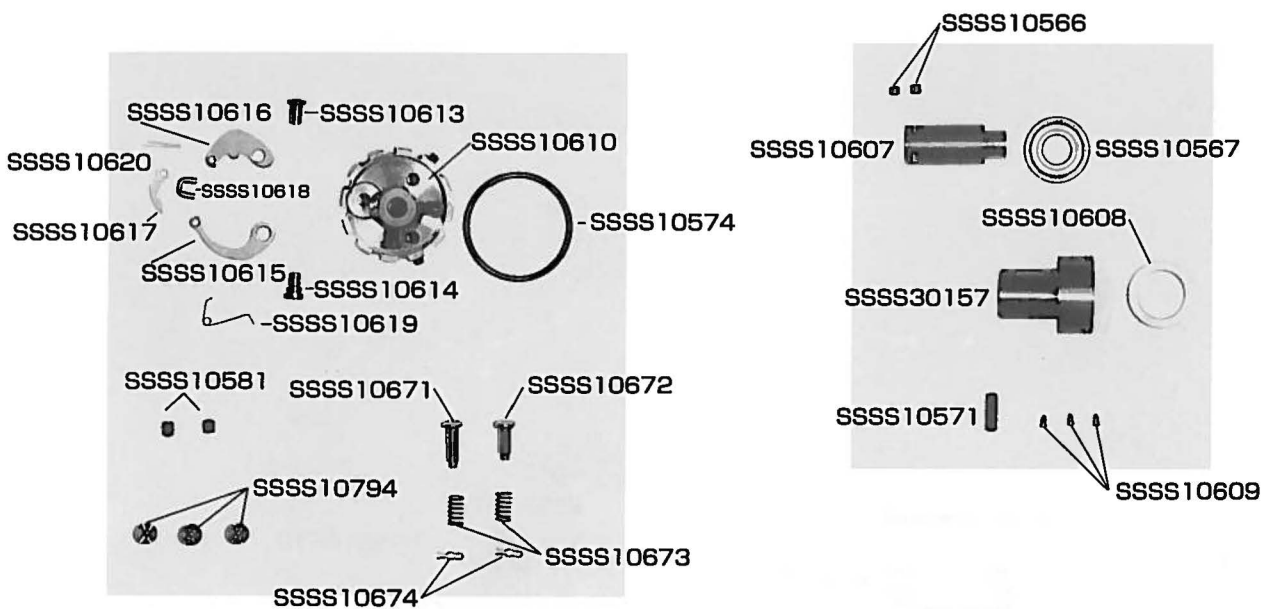
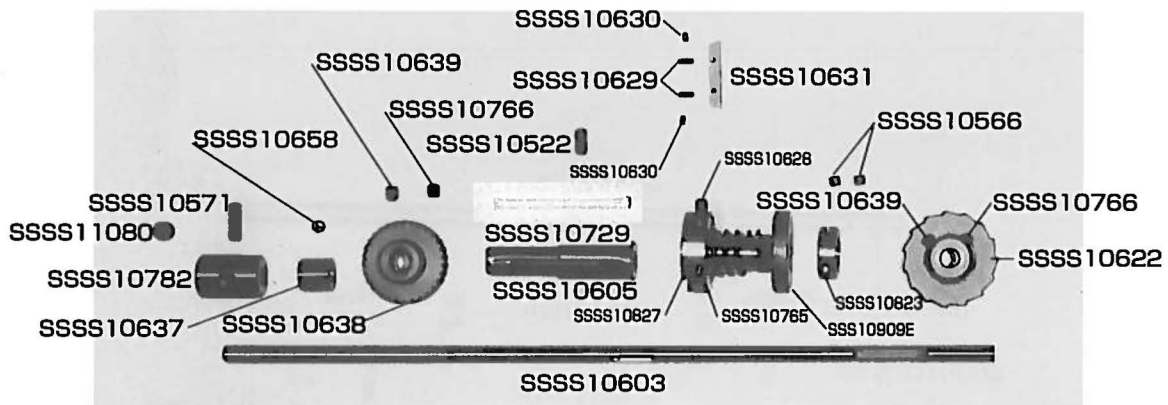



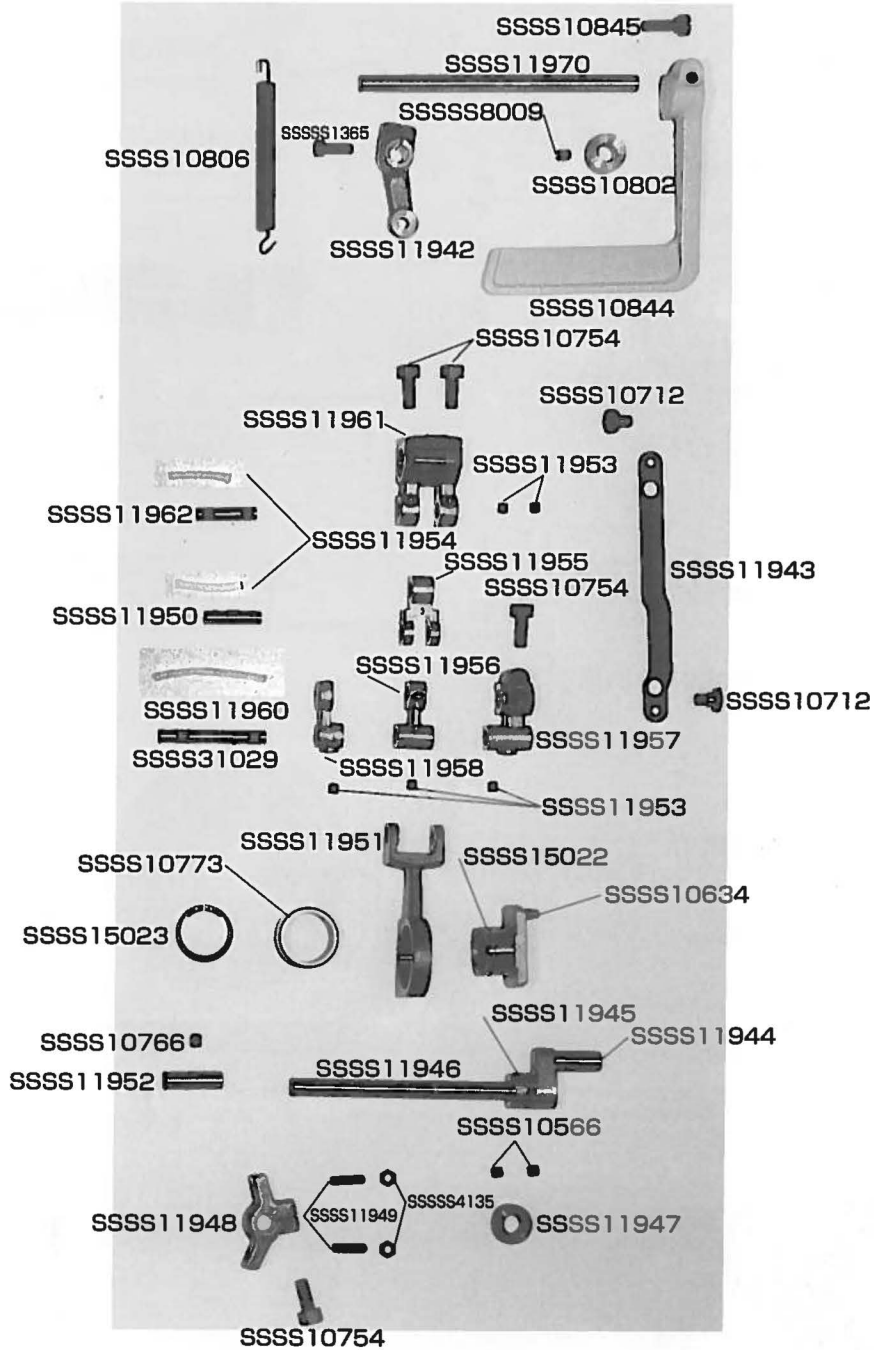

7. 返し縫い関係 / Reversing Mechanism

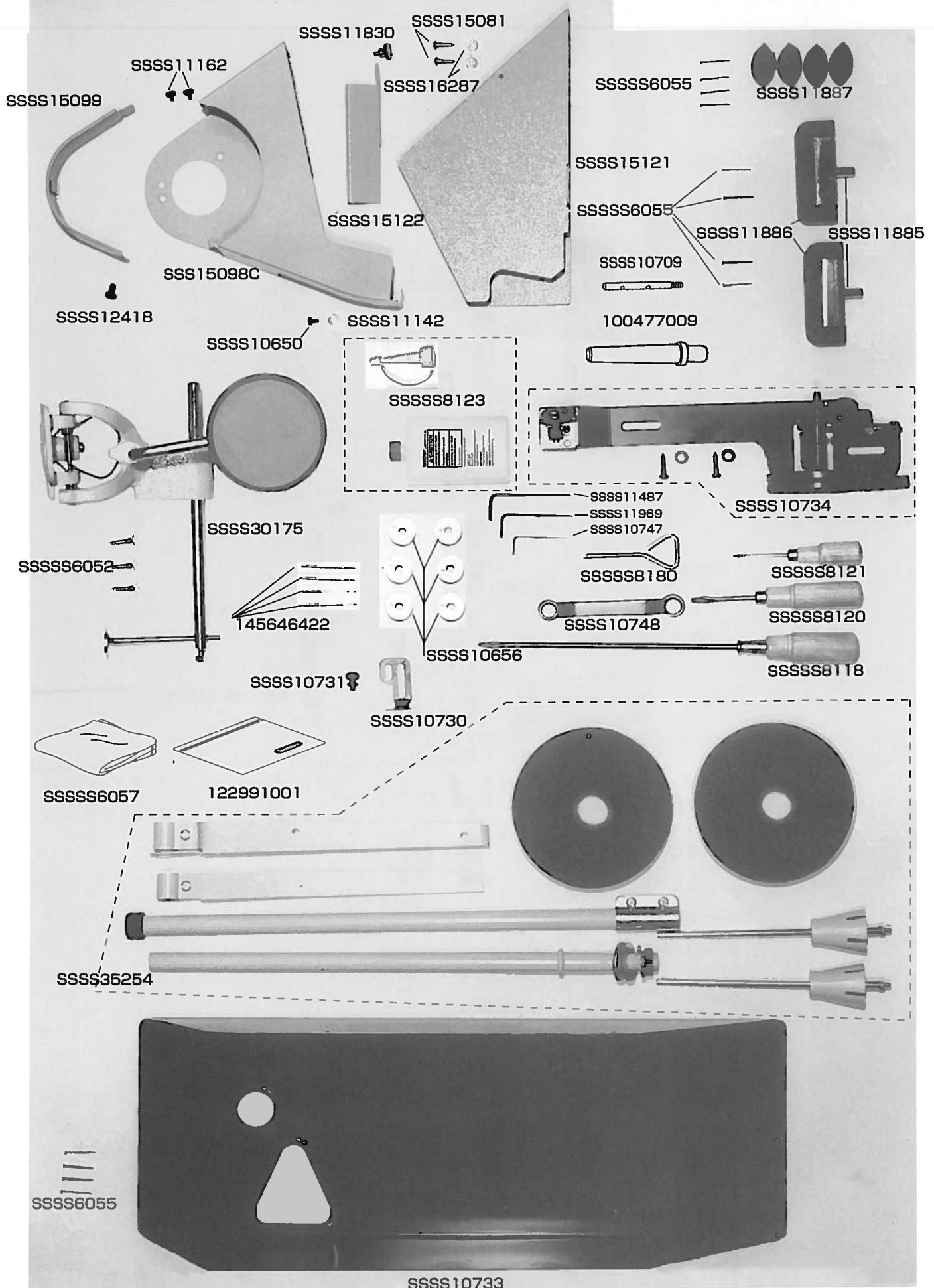

8. ベルトガード・付属品関係/Belt guard, Accessories



警告ラベル / Warning labels / Warnschilder
 / Etiquettes d'avertissement / Etiquetas de advertencia

	品名 / Name of part	Size(mm)	Code
	ワーニングマーク Mark, injury	L=16 R=0.8	S36924-001
	矢印マーク Mark, arrow	10 × 30	S37058-001
	アースマーク Mark, grounding	φ 12	S37060-001
	Label, operation Eng.	40 × 64	S38349-001

brother®

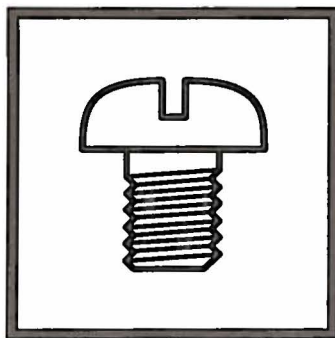

パーツブック
PARTS BOOK

ブラザー工業株式会社

BROTHER INDUSTRIES, LTD.

〒467 名古屋市瑞穂区河岸1丁目1番1号 TEL (052) 824-2392 (代)

Printed in Japan

F53A
S9553A-001
1995.12H ①

From the library of: Superior Sewing Machine & Supply LLC